

EV, ET, EC SERIES 3-WAY NORMALLY CLOSED VALVES MANIFOLD MOUNT

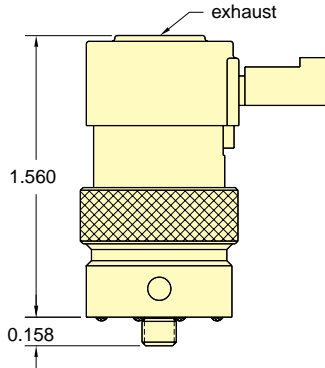

EC - 3M - □ - □



ET - 3M - □ - □

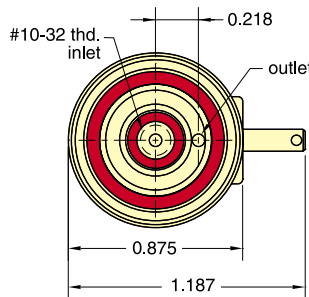

EV - 3M - □ - □

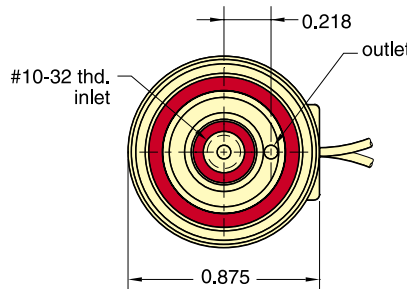

Type: Normally Closed 3-Way
Medium: Air (40 micron filtration)
Temperature Range: 30° to 180° F
Power Consumption: 0.67 watt
Response: 5 - 10 milliseconds
Mounting: Manifold
Ports: Manifold mounted with #10-32 stud
Operating Range: 90% to 150% of rated voltage
Air Flow: 0.6 scfm @ 100 psig
 "L" option - 0.5 scfm @ 50 psig
 "H" option - 0.45 scfm @ 25 psig
Pressure Range:
 28" Hg Vac. to 105 psig
 "L" option:
 28" Hg Vac. to 50 psig
 "H" option:
 28" Hg Vac. to 25 psig



For Cable and Connectors, see Page 184.

NUMBERING SYSTEM

E □ - 3 M - □ - □

C - Connector
 T - Terminal Spades
 V - Wire Leads

Voltages: *
 6 - 6 Volts
 12 - 12 Volts
 24 - 24 Volts

Standard Options:
 Blank - Standard orifice 0.025
 L - 0.040 orifice (50 psig max)
 H - 0.060 orifice (25 psig max)
 V - Viton® seals
Non-Standard Options:
 E - EPR seals
 S - Silicon seals
 D - Diode

* Consult factory for availability of non-standard voltages and other options